

VMMS24
24 TONNE CAPACITY MACHINERY MOVING SKATE

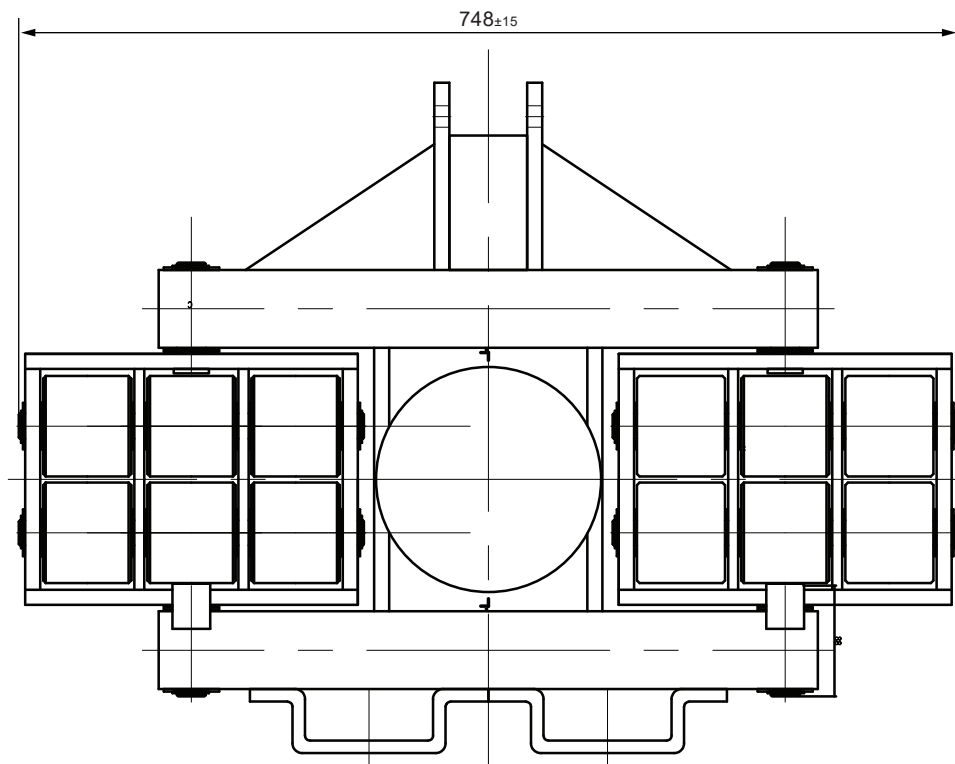

1. VMMS12S

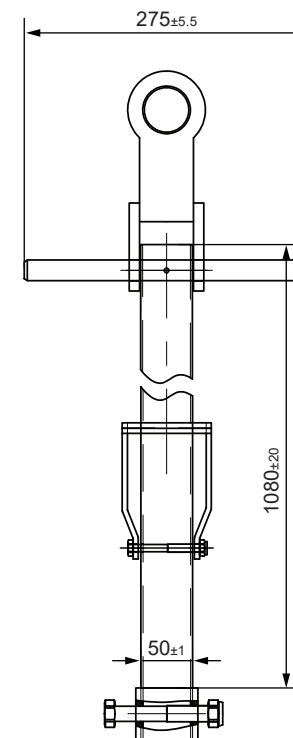
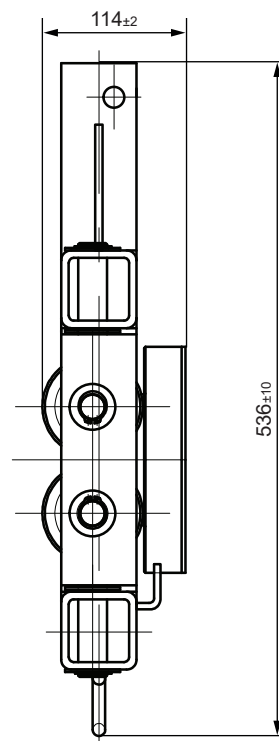

HAND LEVER

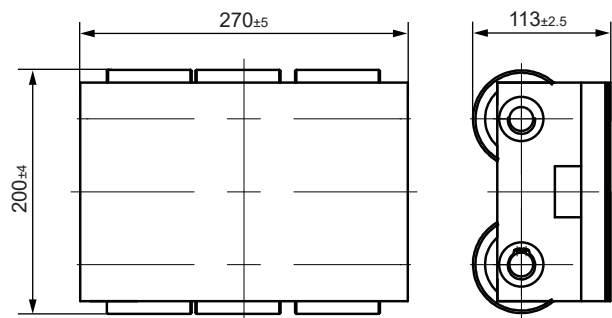

2. VMMS6T

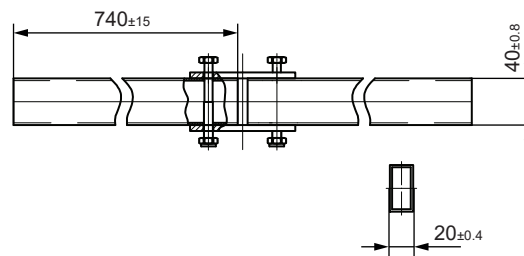

CONNECTOR BAR

Assembly (24t) consists of the following:		
Item	Product	Qty
1.	VMMS12S - 12T STEERING SECTION	1
2.	VMMS6T - 6T TRAILING SECTION	2
3.	TRAILING SECTION CONNECTOR BAR	1
4.	STEERING SECTION HAND LEVER	1

24 TONNE MACHINERY
MOVING SKATE SET

APPROVED	DATE
Josh Ranford	17.11.2022
Drawing ID	VMMS24/171122GT

PAGE 1 OF 1



GEORGE TAYLOR
LIFTING GEAR
(MIDLANDS) LTD.