

EPT20H-550X1000 HEAVY DUTY

LITHIUM PALLET TRUCK

24 HOURS
BUILT TO WORK



midland
pallet trucks

SMART POWERFUL DURABLE

BUILT TO WORK
24
HOURS

SMART SIZE

ALMOST SAME

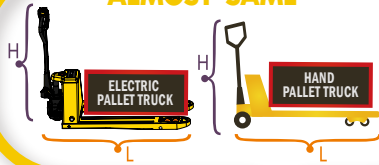

LIGHT WEIGHT



ONLY 125kgs

80kgs

EFFICIENCY

3 Times Higher Than Manual Pallet Truck



VS



LIFETIME

3 Times Longer Than Manual Pallet Truck



1 PC

VS

3 PCS

EASY MAINTENANCE

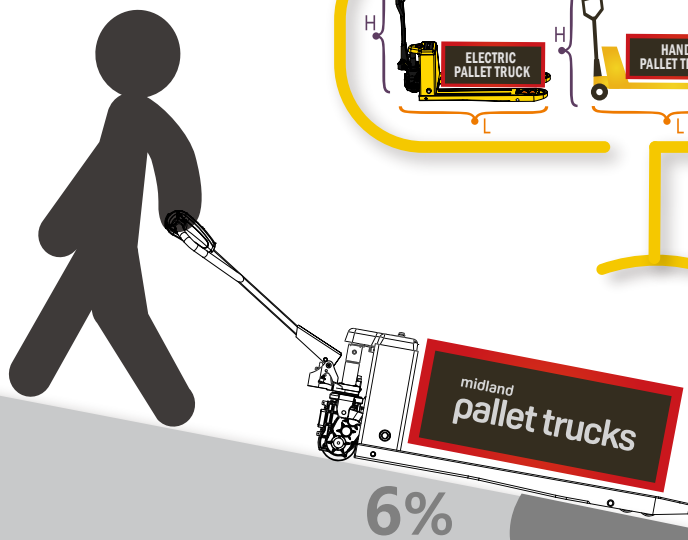
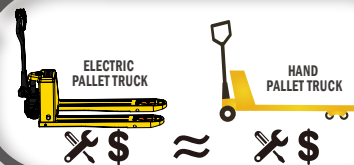

6%

HIGH RETURN OF INVESTMENT

Safety

PRODUCTIVE

1 MONTH COST RECOVERY

Optimize your operations
SAVE LABOUR
Brake any time anywhere

Release manpower

Powerful With High Gradeability



Unique brushless technology

Brushless motor, powerful and maintenance free.
Leading in the industry.

 **1000W power**
Brushless motor
Maintenance free

 **Powered traveling**

 **Powered lifting & lowering**

Maintenance free

For brushed motor, carbon brush needs to be replaced every 12 or 18 months.
For EPT15H, no need to replace carbon brush.
Maintenance-free, saving maintenance time and cost.

Powerful with high gradeability

To easily move 1.5 ton or 2 ton over the slopes at warehouse entrances.



 **UNLADEN 4.5km/h**
Traveling speed + **LADEN 4km/h**

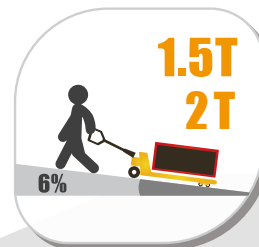
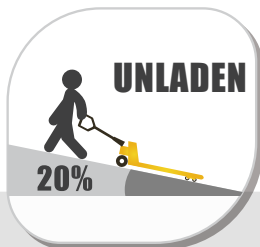

Gradeability



Non-stop Working

6s to replace battery

Maintenance-free lithium battery
It takes only 6s to replace battery.
With a spare battery, the unit can keep working 24 hours.

Ensured battery safety

Safe and reliable, no fire, no explosion.
Complying with IEC, UL global standard certification requirements,
ensuring the safety of user property.

- Long service life: lithium battery with a long service life.
- High safety performance: it adopts soft package battery technology, built-in protection board and multiple protection to eliminate overcharge and overdischarge.
- Maintenance free: no need to add water.

Compact and durable

Solid build, no breaking

Chassis made by solid materials, no bending, no deformation.
Reinforced rocker arm, push rod, wheel frame and support seat.
No plastic part, less damage.

Most compact unit with same lifting capacity

Suitable for small workplaces such as compact workshops,
trucks or vans, tail lifts or elevators.
EPT15H has the smallest turning radius among similar products.

Integral forks, no splicing

The forks are uniquely designed, easy to handle European
pallets, American pallets and plastic pallets.
Solid fork with no deformation, far more durable than other
brands of the same category.

Short charging time Charge and use freely

Quick charging: 2 hours to fully charge the battery
using the optional Quick charger.

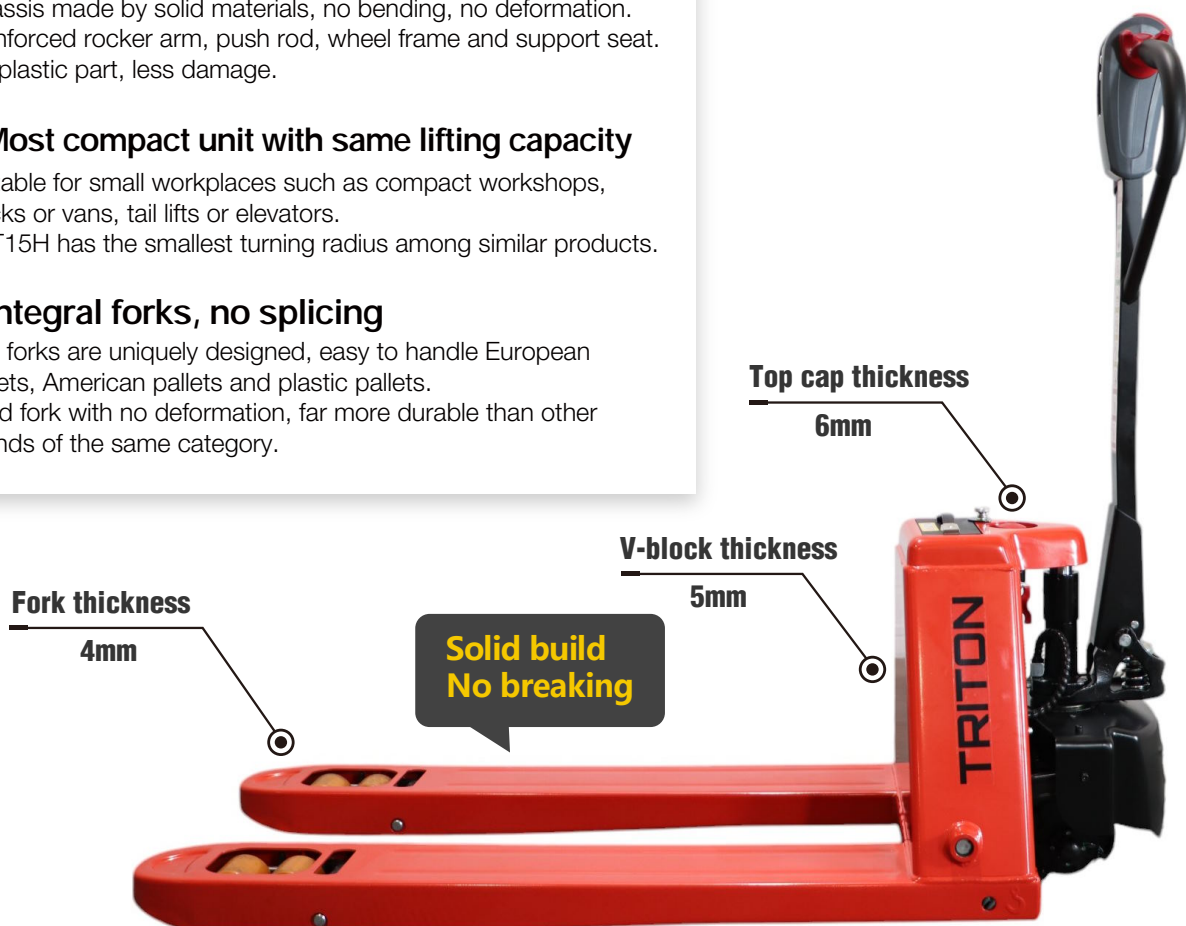

Intelligent Control

When you're moving heavy loads in tight spaces, maneuverability and controllability are critical to ensure safety, productivity and comfort.

The core concept of MIDLAND products is to make your job easier. With the ergonomically designed handle, EPT15H is easy to operate, reduces fatigue and improves work efficiency. Compared to other brands, users prefer to use MIDLAND EPT series.



Operator Preferred

Turtle Speed

01

Horn Remains Pressed & Forward 2 times

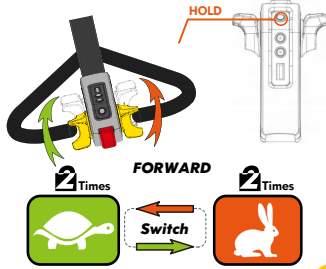

Up-Right Drive

02

Reverse Button & Forward Throttle Remain Pressed Power On

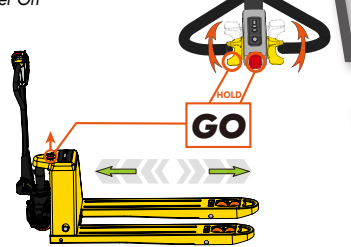

Engineering Mode (Brake Release)

03

Horn Remains Pressed Power On

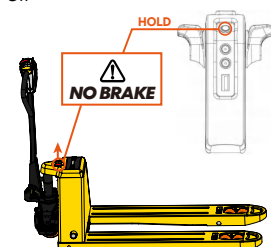

- ⚠ In up-right drive mode, vehicle will move when handle is operated at any position. Please avoid misoperation.
- ⚠ Brake release mode is only for emergencies, not allowed for vehicle with normal conditions.

Comfortable Operation

Easy to operate
Ergonomic handle, comfortable to use.

Leading Technology

CanBus technology is applied on this entry-level electric pallet truck.

Fast And Slow Speed

To match different levels of operator experience, and varied work environments.

Up-right Drive Mode

Convenient to operate in vans, on tail lifts, or inside elevators.

Engineering Mode

When the unit breaks down, it can be moved away manually.



- 🔌 Recharge alert
- 🔋 40% Hour meter
- 🎯 Powered traveling
- ⬆️⬆️ Powered lifting & lowering
- ⚠ Error code display
- 🛑 Emergency stop button
- 🔊 Horn

Slope anti-sliding design

Easy parking on slopes, preventing accidental backing of the machine.

Easy Maintenance

EPT series utilizes MIDLAND's integrated diagnostics, error code display and MIDLAND's original service mini-program to facilitate quick problem resolution.

Easy parts replacement

The unique design makes disassembly and assembly simple, reducing machine downtime and operating costs.

- **1 minute**
Replace the drive wheel
- **1 minute**
Replace the handle
- **2 minutes**
Remove the controller
- **3 minutes**
Remove the motor



Error Code Display

Quickly identify the fault during operation.

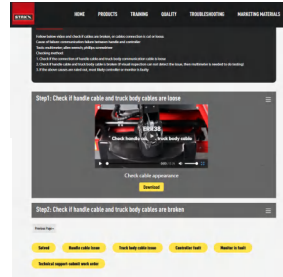

Specialized service website & mini-program

Users can identify the fault based on the online troubleshooting videos. No limit on time, no limit on location. Easy access to the most professional solution to all possible truck failures.

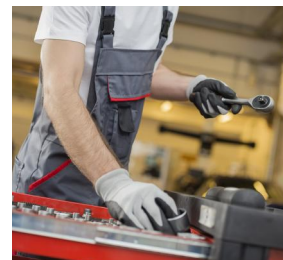

Professional after-sales support

Specialist guidance is a phone call away.

Ready to Handle Multiple Jobs

With its unique design, EPT series is powerful and maneuverable to meet the application in a wide range of working conditions.

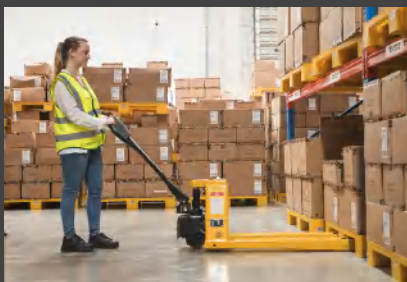

Warehouses/Logistics center



Truck tail lift



Supermarket

Pallet trucks are a necessary investment. Choosing the wrong machine could cause loss in productivity, high cost of machine downtime, unhappy workers, and overall, increased running costs. Choosing EPT series will reward you with long-term value.

MIDLAND EPT Series

- Powerful
- Durable
- Easy maintenance
- Low use cost
- High return on investment

Basic Configuration

- Horn
- Emergency reverse button
- Forward/reverse butterfly switch
- Lifting / Lowering

- LCD Screen**
- Battery indicator with hour meter
 - Error code display
 - Recharge alert



Multi-function Handle (Full Electric)

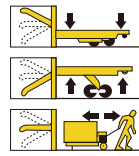

Multi-function Ergonomic Handle (Semi-electric)



Tandem/Single PU wheel



Lithium Battery



Protection cover
Protect the drive motor,
Anti-foot stamping



Intelligent charger



Electric lifting/lowering



Manual lifting/lowering

Dimensions

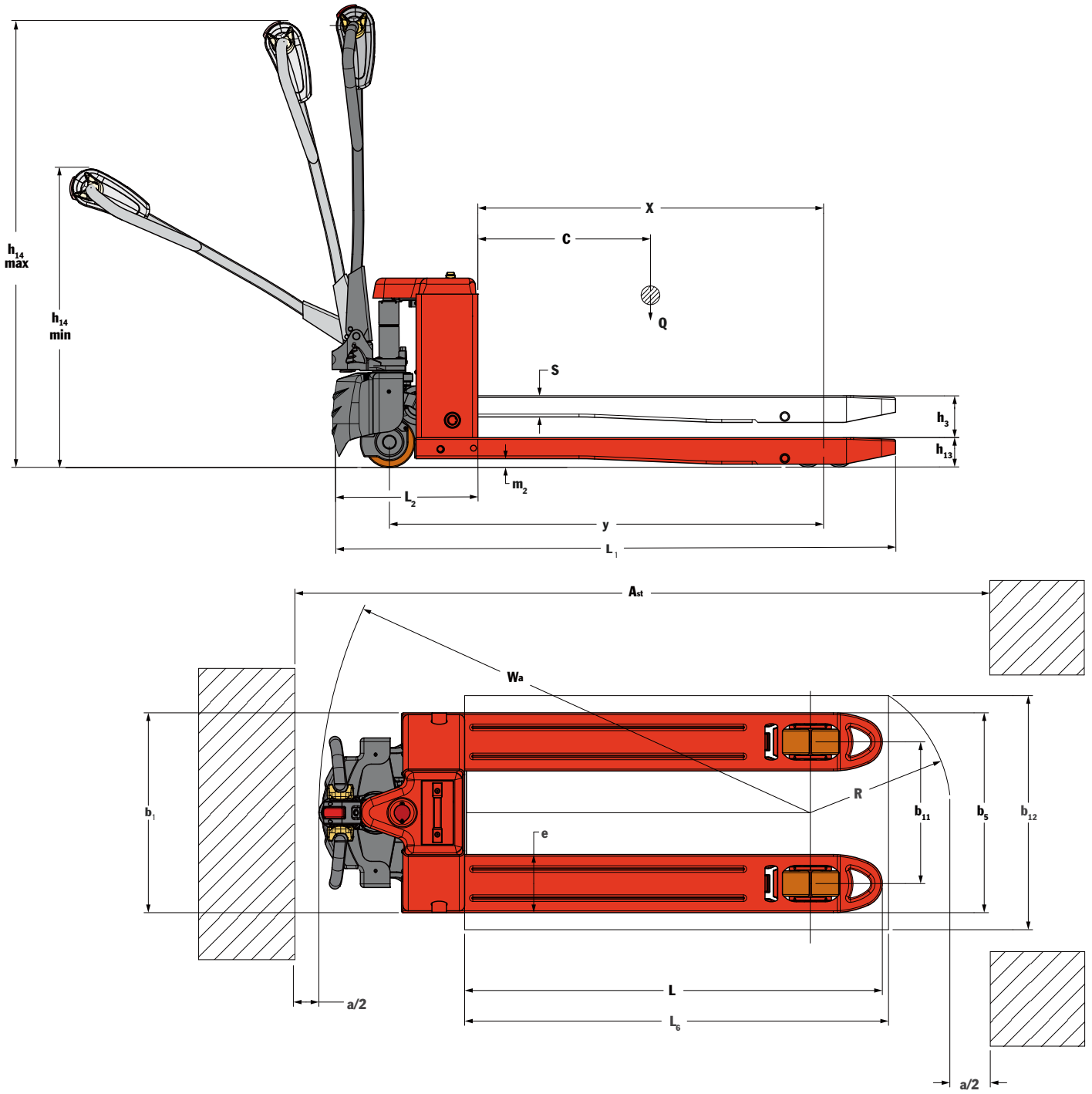

Specifications

MODEL		EPT20H	
CHARACTERISTICS			
1.1	Drive		Electric
1.2	Operator type		Pedestrian
1.3	Load capacity/rated load	Q kg	2000
1.4	Load centre	C mm	600
1.5	Height, fork lowered	h ₁₃ mm	82 ± 2
1.6	Wheelbase	y mm	1197
1.7	Wheel		PU
1.8	Wheel size, front	mm	140*55
1.9	Wheel size, rear	mm	80*70 (Tandem)
		mm	
1.10	Wheels, number front/rear (x = drive wheels)		1x+2/4
1.11	Lift	h ₃ mm	195
1.12	Height of tiller in drive position, min./max.	h ₁₄ mm	735/1170
1.13	Overall length	L ₁ mm	1402
1.14	Fork Length	L mm	1000
1.15	Overall width	b ₁ mm	550
1.16	Fork dimensions	mm	58/160/1000
1.17	Overall fork-arms Width	b ₅ mm	550
1.18	Ground clearance, centre of wheelbase	m ₂ mm	22/137
1.19	Aisle width for pallets 1000x1200 crossways	A _{st} mm	2155/2226
1.20	Aisle width for pallets 800x1200 lengthways	A _{st} mm	2024/2064
1.21	Turning radius	W _a mm	1353
PERFORMANCE			
2.1	Travel speed, laden/unladen	km/h	4.0/4.5
2.2	Lifting speed, laden/unladen	mm/s	18/23
2.3	Lowering speed, laden/unladen	mm/s	56/46
2.4	Max. gradeability, laden/unladen	%	6%/20%
2.5	Drive motor	kW	DC 1.0 Brushless
2.6	Lift motor	kW	DC 0.8
BATTERY			
3.1	Battery voltage/nominal capacity	V/Ah	48V/10Ah
3.2	Traveling brake		Regenerate
3.3	Brake		Electromagnetic
3.4	Sound level at the driver's ear according to EN 12053	A	< 70dB
3.5	Service weight including battery	kg	119

MAKE
YOUR JOB
EASIER!

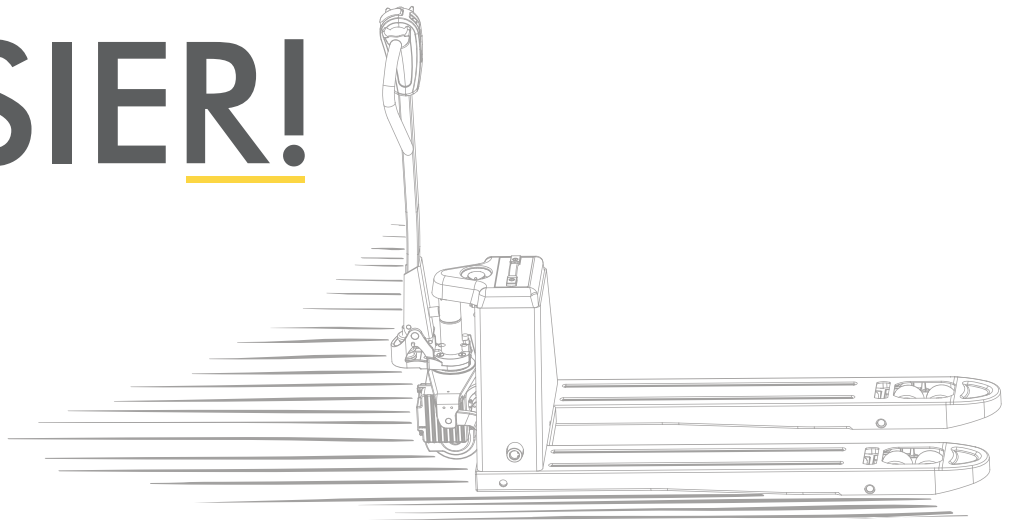

midland
pallet trucks

Email: sales@midlandpallettrucks.com

Phone: 01384 841440

Web: <http://www.midlandpallettrucks.com>

Add: Midland Pallet Trucks, Building 33 Second Avenue,
Pensnett Trading Estate, Kingswinford, DY6 7UG